

INFINITY LOAD MONITOR

Wireless handheld indicator

Operating Instruction

Table of contents

Description -----	1
Work principle -----	1
Dimensions -----	1
Profile -----	2
Operation -----	2
Calibration -----	3
fittings -----	4
Maintenance -----	5

Wireless handheld indicator

Description

Worldwide licence exempt: 2.4GHz operating frequency

Range Min: not less than 100m

Battery working life: Active not less than 70 hours
(full charge and turn off backlight)

LCD: LCD 128*64 with backlighting
show weight value: 6 bit
show working capacity of battery
show intensity of signal

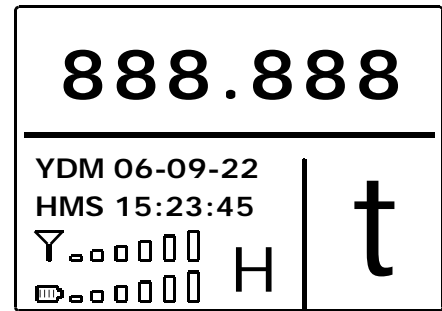

LCD

Hold on the peak value

Can contact with computer by RS232

Work Principle

First, the load cell's out-put signal is digital, Digital compensation and temperature compensation will be finished in internal. Through 2.4G wireless module to launch after reasonable encoding.

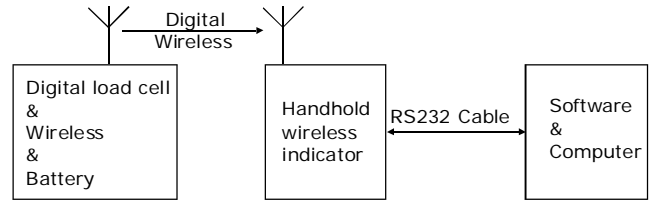

The indicator receives load cell output and its capacity of internal battery then show them on the LCD, and handheld can connect to computer or large-screen through the RS232 output. If necessary, the indicator can work as Multi-channel, One handheld indicator can manage to up to 16 senders.

Dimensions

(In mm. 1mm = 0.03937 inches)

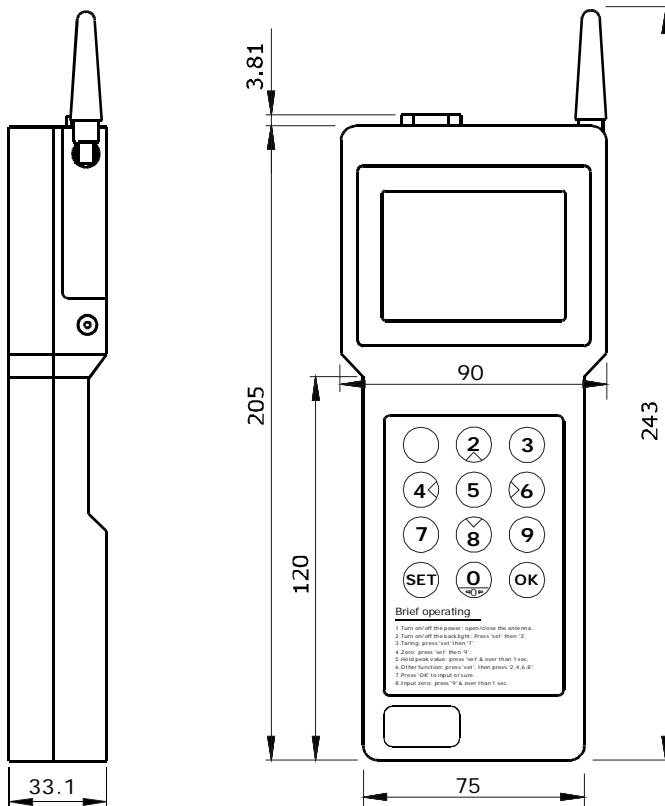

That dimensions are for logo which are as following drawing.
Deep: 0.5mm

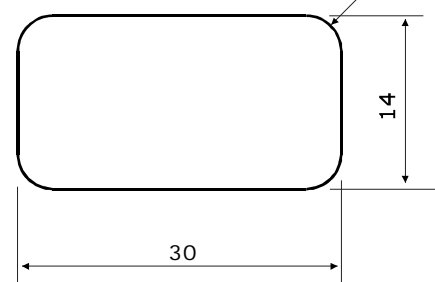

If you want to show the LOGO of your company on this indicator, you can make a label with that dimensions, then labelled.

Wireless handheld indicator

Profiles

LCD show

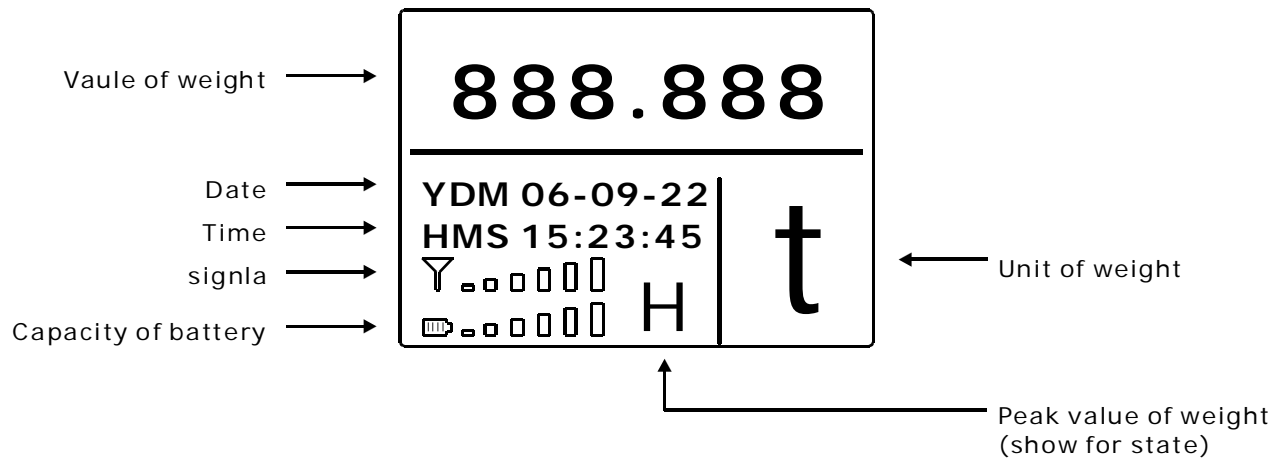

Keyboard show

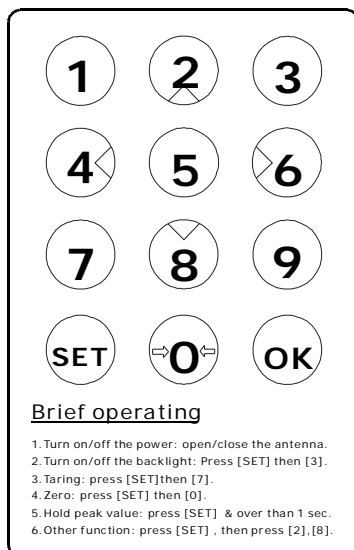

Keyboard

Brief operating

Key[0~9]: Number key.
 Key[2. 4. 6. 8]: Direction key.
 [2]---up
 [6]---right
 [4]---left
 [8]---down
 Key[SET]: Function key.
 Key[OK]: For sure.
 Key[0]: Zero key, for zero return.
 Press [SET] then [0].

1. Turn on/off the power: open/close the antenna.
2. Turn on/off the backlight: Press [SET] then [3].
3. Taring: press [SET] then [7].
4. Zero: press [SET] then [0].
5. Hold peak value: press [SET] & over than 1 sec.
6. Other function: press [SET] , then press [2],[8].

Operating

A. Turn on/off the unit

1. Turn on
Turn up 180 degrees antenna, the power will be on, When you hear " di" , LCD will show normal weight interface.
2. Turn off
Tune down 180 degrees antenna, the power will be off.



B. Turn on/off the backlight

- Press [SET] then [3].

C. Zero return

- Press [SET] then [0]. Zero range is 5% F.S.

D. Tare

- Press [SET] then [7]. Taring range is 20% F.S.

Operating

E. Start a new weight bill

when the LCD is showing natural weight interfac.

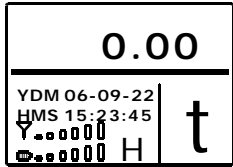

If does not show zero, please press [SET] then [0].

Put a weight on the load cell or scale, LCD will show a value of the weight, till the value is stable.

Press [OK], then show:

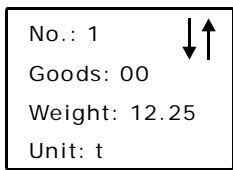

No.: 1 is a serial number, autogeneration.

Goods: 00 is for goods number.

Weight: 12.25 is current weight value.

Unit: t the weight unit is in ton.

Press [8] for more information.

Press [OK] to save above data and return weight interface, or press [0] to cancel.

F. Read the bill of history

When the LCD is showing normal weight interfac.

Press [1] to show No.1 item of history,

Press [6] to read next item,

Press [4] to read front item,

Press [2] or [8] to up or down.

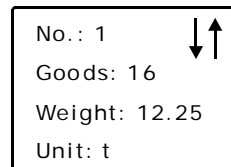

G. Testing for the peak value

New record: press [0] for delete last peak value. start a new record.

Show the peak value of weight: press and hold [SET], then quickly loosen that key after you hear <Di>.

LCD will show the peak value with a H word which is reverse video.

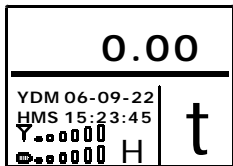

Normal interface

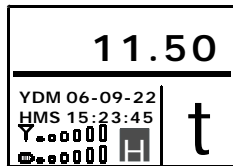

Show the peak value

Calibration

A. Change a compatible unit of weight

Press [SET], choose 3. Unit—t—kg—lb by [8], Press [6] for choose the unit, press [OK] to sure. Press [0] to exit and return.

B. Setting date and time

Press [SET], choose 5. Date—2000-01-01 by [8], Press [6] for choose a number, press [2] or [8] to adjust. Press [OK] to sure. Press [0] to exit and return.

C. Setting divition

Press [SET], choose 7. Divition—00.001 by [8], Press [6] for choose a number, press [2] or [8] to adjust. Press [OK] to sure. Press [0] to exit and return. Note: that value should nearly to about 1/3000 F.S.

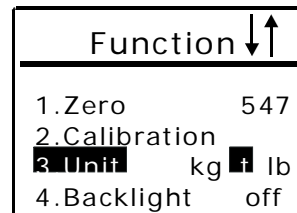

Wireless handheld indicator

Calibration

D. Calibration

Press [1] to set zero, put a standard weight on the load cell (or scale) which is with sender, choose 2. Calibrate by [8] key, then press [6] key, you can see "****", please input password 6863, press [OK] key if the password is right, so you can see "00000" press [2] or [8] key collect value to current standard value, press [OK] key, the system will count calibrate coefficient and save value automatically.

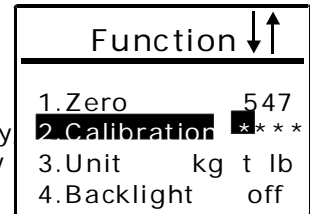

E. Adjust the coefficient of calibration

The coefficient of calibration can be read or adjusted when you choose the function [9]. Please save the value on a card beforehand. You need a password for adjusting, that is 6863, there are two parts in the value, the anterior part is for positive coefficient (the signal of load cell from zero to Max), and the latter part is for minus coefficient. Usually, they are same.

That values are in hex code, which are very important to you.

1. It can adjust the rated output after change their value.
2. No need to recalibrate when you use a new indicator, you only input them in new indicator.

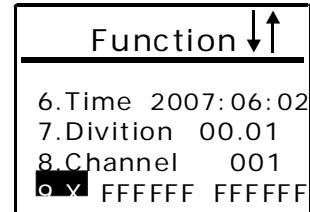

F. Change the channel

If you need connect indicator to another sender, Press [SET], choose 8.Channel—001 by [8], Press [6] for choose a number, Press [2] or [8] to adjust, Press [OK] to sure, Press [0] to exit and return, Restart the unit.

Note: The code should be accordant with wireless sender's.

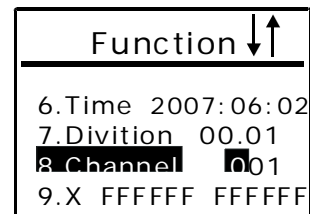

RS232

This indicator is equipped with standard RS-232 output interface, it can communicate with computer or connect with large screen LCD.

The format of serial output is: 1 start bit, 8 data bits, 1 stop bit, no parity bit, baud rate is 9600.

Data adopt ASCII character, transmission is continuous and single direction.

Format is: = X1,X2,X3,X4,X5,X6,X7,SA,CR

X1 is low digit of data, X2 is high digit of data. Decimal point and sign are included in X1 ~ X7

SA is status byte:

D7							D0
print	1	0	0	overflow	net weight	stable	zero point

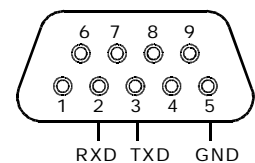

We have a testing software for setup, and which is free, please connect us for get it.

Fittings

A. Charger

Model: PRS-Z30US9

Input: 100~240 V, 50~60 Hz, 0.8A Max

Output: 8.4V DC, 0.5A

There is a LED light for show the status,

it is charging when the shine of LED is red,

it is full charged when the shine of LED is green.

A. Testing software

Please check the file of help, Which is in the software.

Maintenance

- A. To guarantee indicator clarity and using life, the indicator shouldn't be placed directly under sunshine and should be set in the plain space.
- B. The indicator can't be placed into the place where the dust pollution and vibration are serious.
- C. It is strictly forbidden to clean the case of indicator with intensive solvents (for example: benzene and nitro oils).
- D. Liquid and conducting particle should not be poured into the indicator, otherwise the electronic components will be damaged and electric shock is likely to happen.
- E. You should cut off power supply of indicator and relevant device before you pull-in and out the connecting line of indicator and external device.
 - ◆!You must cut off power supply of the indicator, before you pull out connecting line of the RS232 port.
- F. During operation, if trouble occurs, operator must pull off the power supply plug immediately, and user should return this indicator to our company for repair. Non-weighing manufacturer should not repair it, or by yourself, otherwise further destruction may happen.
- G. The storage is not granted the free repair guarantee, because it is easily exhausted products.
 - ◆!In order to prolong using life, please charge the unit fully before using it.
 - If you don't use the indicator for a long time, you must charge the unit every two month and for eight hours/each charging time.
 - ◆!Moving or installation must be carefully taken and must avoid strong vibration, impact and bump in order to protect the storage cell from being damaged.
- H. From invoice date, the indicator has a one-year free repair period. If any non-artificially obstacle about the indicator happens under correct using conditions within this period, the user is allowed to send the product with its guarantee card (of the correct number) back to our corporation for free repair. The indicator shouldn't be taken apart, otherwise free guarantee will be cancelled.